

JANOME



Bias Tape Foot



Beading Foot



**1200D
Professional**

Optional Accessories

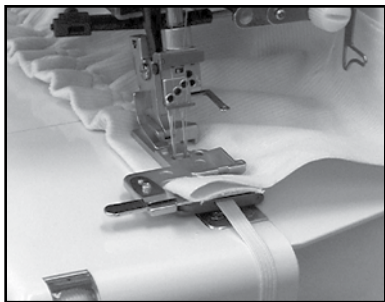

◀ ELASTIC GATHERING FOOT (C) AND ELASTIC GATHERER (3 SIZES)

The elastic gathering foot not only takes the hard work out of evenly attaching elastic, it is also great for making your own custom soutache. Simply snap on one of the three elastic gathering attachments to quickly sew 7.5 mm, 10 mm, or 13 mm (1/4", 3/8" or 1/2") flat elastic directly onto fabric using either a three or four-thread overlock stitch. Another option with this versatile foot is to create shirring with Cover Hem stitching.

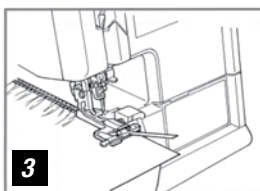
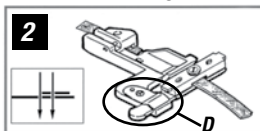
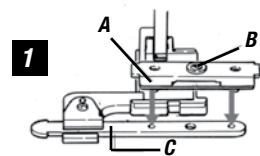
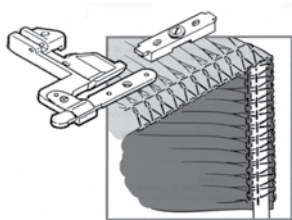

OVERLOCKING ELASTIC GATHERS

1. Select sewing program:
 - (1) Safety 4-Thread Stitch or
 - (2) 3-Thread Stitch Wide
2. Thread and set up machine as indicated on the machine or in your instruction manual. Set Stitch Width Dial to widest width. Set SL to 3 1/2-4. Test Sew.
3. Attach elastic gathering foot. Snap elastic gatherer "A" onto elastic gathering foot. **See Figure 1.**
4. Loosen adjustment screw "B" and insert elastic into slot "C". (Cut a generous length to allow for test sewing.) Pull elastic under foot and extend it behind foot. Tighten screw "B" to set amount of gathering. **See Figure 1.**
5. Position guide "D"; the elastic should be on the needle plate right edge and next to cutting blades. Place fabric with right side up under elastic in front of cutting blades. **See Figure 2.**
6. Lower needle(s) into fabric. Lower the presser foot. Sew first two stitches by hand turning handwheel. Test sew, adjusting elastic gatherer for fullness and checking that only fabric and not the elastic is being cut. Sew at medium speed. **See Figure 3.**

NOTE:

If you are using elastic lace, insert lace scallop to left side of elastic gatherer.

COVER HEMMING ELASTIC GATHERS

1. Select sewing program:
10 Triple Cover Hem, Cover Hem Wide or
Cover Hem Narrow
2. Thread and set up machine as indicated on the machine or in your instruction manual.
Set SL above 3.5.
FOLLOW steps 3 and 4 under “Overlocking Elastic Gatherers”
5. Position guide “D”; the elastic is centered underneath needles. (Option: Press under fabric edge 1/4”. Place folded edge right side up under elastic.)
6. Lower needles into fabric. Lower the presser foot. Sew first two stitches by hand turning handwheel. Test sew adjusting elastic gatherer for fullness. Sew at medium speed. **See Figure 3 on page 1.**

HINT: Use a washable fabric marker to draw guidelines for sewing multiple rows of elastic and create a unique shirring effect.

CREATE CUSTOM SOUTACHE USING 7.5 MM ELASTIC GATHERER

1. Select sewing program:
(2) 3-Thread Stitch Wide
2. Thread and set up machine as indicated on the machine or in your instruction manual with decorative thread in upper looper. Set Stitch Width Dial to widest width. Disengage (lower) cutting blade.
3. Attach elastic gathering foot. Snap elastic gatherer “A” onto elastic gathering foot.
4. Loosen adjustment screw “B” and insert 1/4” tape/ribbon into slot “C”. (Cut a generous length to allow for test sewing.) Pull tape/ribbon under foot and extend it behind foot.*
5. Position guide “D”; the tape/ribbon should be to the right of the needle and to the left of the needle plate edge. **See Figure 2 on page 1. DO NOT** tighten the adjustment screw. Lower needle (do not catch edge of tape/ribbon).
6. Lower the presser foot. Hand turn the handwheel and adjust Stitch Width Dial so stitching surrounds width of tape/braid. Continue turning handwheel and adjust Stitch Length Dial until desired look is achieved. Sew at medium speed. Hand sew braid onto project.

*NOTE:

You may need to adjust SL for thicker threads.

Elastic Gathering Foot (C):	200-805-009
7.5 mm Elastic Gatherer:	200-805-102
10 mm Elastic Gatherer:	200-805-205
13 mm Elastic Gatherer:	200-805-308

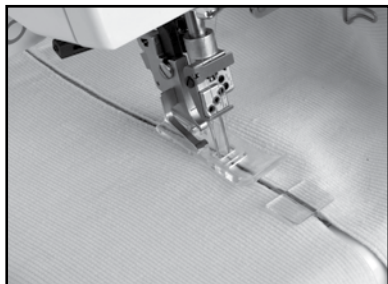

◀ CHAIN STITCH FOOT (F) AND FAGOTING GUIDE (F-2)

Fagoting is a lovely lacy effect that is created between two fabrics. The fagoting guide keeps the fabrics separated at an equal distance. Use different colored threads to achieve unique decorative effects.

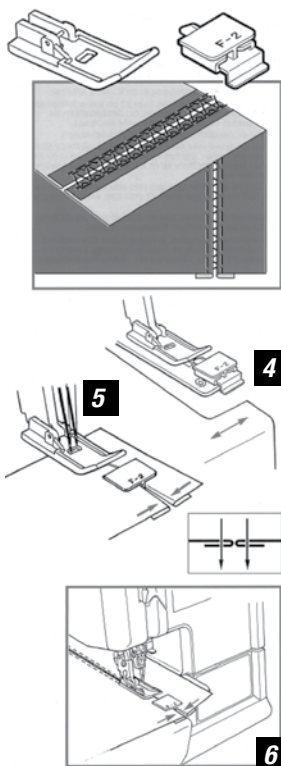

COVER HEM FAGOTING

1. Select sewing program:
(10) Cover Hem Wide
2. Thread and set up machine as indicated on the machine or in your instruction manual.
3. Attach chain stitch foot.
4. Open left side cover. Insert peg on F-2 guide into needle plate hole, close left side cover. **See Figure 4.**
5. Press 6 mm (1/4") seam allowance to wrong side of fabrics (Raw edge should be finished with two or three thread overlock). Insert one folded edge into each side of F-2 guide (top portion only) and place both fabrics under foot. Lower needles into fabrics. Lower presser foot. **See Figure 5.**
6. Sew first two stitches by hand turning the hand wheel. Continue sewing slowly and check that fabric is guided correctly. **See Figure 6.**

Chain Stitch Foot (F):	200-803-306
Fagoting Guide (F-2):	200-803-007

CHAIN STITCH FOOT (F) AND LACING GUIDE (F-3)

Throw away those pins. Accurate alignment of lace or trim to the fabric edge is assured with this guide. Sew lace or trim evenly on top of fabric with a Cover Hem.

CREATE LACE-TRIMMED COVER HEMS

1. Select sewing program: 10 Triple Cover Hem, Cover Hem Wide or Cover Hem Narrow
2. Thread and set up machine as indicated on the machine or in your instruction manual.
3. Attach chain stitch foot.
4. Open left side cover. Insert peg on F-3 guide into needle plate hole, close left side cover.
5. Place fabric (right side up) against lower guide and position fabric under foot. Place lace on the right side of F-3 guide and underneath presser foot.
6. Hand turn handwheel to lower needles into fabric and lace. Lower presser foot. Sew first two stitches by hand turning the handwheel. Hold fabric in your left hand and lace in your right hand and continue sewing. Check fabric and lace placement in F-3 guide.

Chain stitch Foot (F): 200-803-306

Lacing Guide (F-3): 200-803-100

CHAIN STITCH FOOT (F) AND FELLING GUIDE (F-4)

Strong and durable flatfelled seams on jeans and t-shirts are a breeze to create with the felling guide. Attached to the machine, it guides and folds the fabric. Only the upper fabric is folded, reducing the amount of seam thickness.

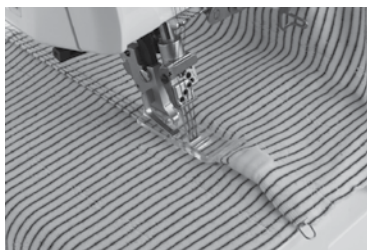

COVER HEM FLATFELLED SEAMS

1. Select sewing program:
(10) Cover Hem Wide
2. Thread and set up machine as indicated on the machine or in your instruction manual.
3. Attach chain stitch foot.
4. Open left side cover. Insert peg on F-4 guide into needle plate hole, close left side cover.
See Figure 7.
5. Place fabric (right side up) against lower guide and position fabric under foot. Fold or finger press approximately 5 cm (2") of the fabric **UNDER** 1 cm (3/8") to wrong side. Insert fabric into upper guide section and position fabric under foot. **See Figure 8.**
6. Lower needles into fabrics. Lower presser foot. Sew first two stitches by hand turning handwheel. Continue sewing at medium speed; check if fabrics are being folded and guided correctly.
See Figure 9. (page 5)

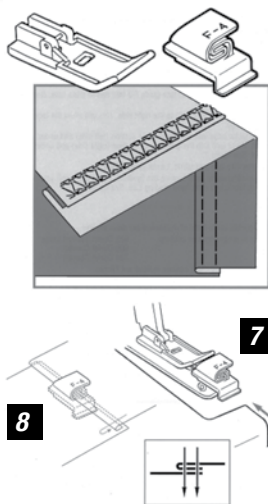

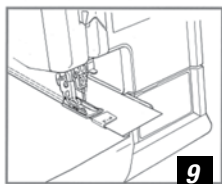

9

COVER HEM FLATFELLED SEAMS

-continued

Chain stitch Foot (F): 200-803-306

Felling Guide (F-4): 200-803-203



◀ COVER HEM FOOT (M) AND LACE ATTACHMENT GUIDE (H-1)

The Cover Hem stitch is used by professionals as a hemming method. This efficient and clever lace attachment guide folds under perfect 6 mm (1/4") hemmed edges. At the same moment it's hemming, it attaches lace or trim placed underneath the fabric. This method of hemming is best accomplished when sewing a hem flat. The side seam is sewn after lace application.

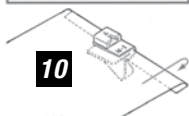
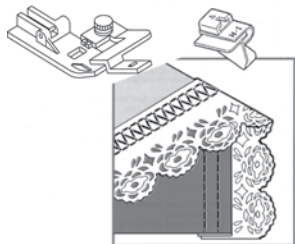

10

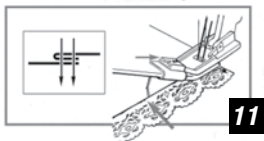

11

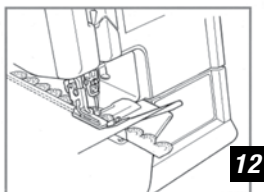

12

FOLD UNDER 1/4" COVER HEM AND ADD LACE TRIM

1. Select sewing program:
(10) Triple Cover Hem or Cover Hem Wide
2. Thread and set up machine as indicated on the machine or in your instruction manual.
3. Attach cover hem foot.
4. Fold or finger press approximately 5 cm (2") of the fabric under 6 mm (1/4") to form hem. Place folded edge into H-1 guide. **See Figure 10.**
5. Raise presser foot, snap guide onto the foot; and slide fabric underneath presser foot. Place lace on the right side of H-1 guide and underneath presser foot, using tweezers as needed. Lower presser foot. **See Figure 11.***
6. Sew first two stitches by hand turning the hand-wheel. Hold fabric in your left hand and lace in your right hand and continue sewing. Check fabric and lace placement in H-1 guide. **See Figure 12.**

Cover Hem Foot (M): 200-801-304

Lace Attachment Guide (H-1): 200-801-005

*NOTE:

Adjust screw to get needle drop in correct position.

COVER HEM FOOT (M) AND HEM GUIDE (H-2)

Would you like to sew a hem where the fabric automatically folds itself? Now you can hem edges evenly without measuring, pinning or pressing. Simply insert the fabric and the guide automatically folds under 2.5 cm (1") at the same time the Cover Hem stitch neatly topstitches the folded fabric. This method of hemming is best accomplished when sewing a hem "flat". The side seam is sewn after hemming.

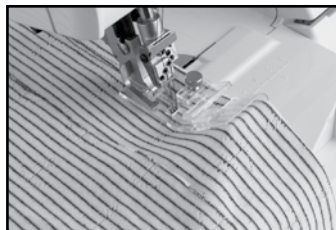

FOLD UNDER 1" COVER HEM

1. Select sewing program:
(10) Triple Cover Hem, Cover Hem Wide or Cover Hem Narrow
2. Thread and set up machine as indicated on the machine or in your instruction manual.
3. Attach cover hem foot.
4. Fold or finger press approximately 5 cm (2") of the fabric under 2.5 cm (1") to form hem. Place folded edge into H-2 guide. **See Figure 13.**
5. Raise presser foot, snap guide onto the foot; and slide fabric underneath presser foot.

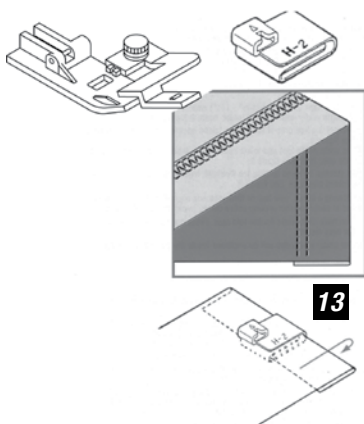

Cover Hem Foot (M):	200-801-304
Hem Guide (H-2):	200-801-108

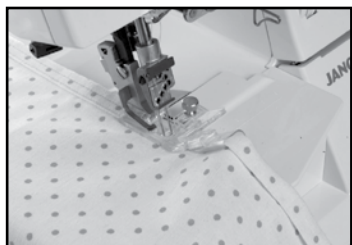

◀ COVER HEM FOOT (M) AND WRAPPED EDGE GUIDE (H-3)

Automatically wrap pre-folded bias binding around an edge and secure it in place with a Chainstitch or Cover Hem. You can create custom made bias tape or use pre-folded bias tape, either looks great.

ATTACH BIAS TAPE TO EDGE

1. Select sewing program:
(10) Chainstitch, Triple Cover Hem, Cover Hem Wide or Cover Hem Narrow
2. Thread and set up machine as indicated on the machine or in your instruction manual.
3. Attach cover hem foot.
4. Cut a length of bias tape 3.5 – 4.5 cm (1 3/8" – 1 3/4") wide. Press one side* or both sides of tape length under into a finished folded width of 2.5 cm (1"). Place folded edge(s) into H-3 guide. **See Figure 14.**
5. Raise presser foot, snap H-3 guide onto foot and position tape underneath the presser foot. Lower needle(s) into tape. Lower the presser foot. **See Figure 15.**
6. Sew first two stitches by hand turning the hand-wheel. Insert fabric into the fold of the bias tape. **See Figure 16.**

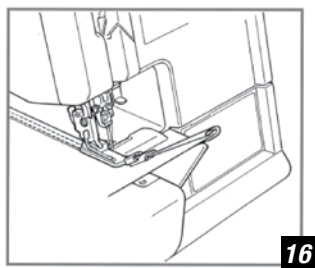
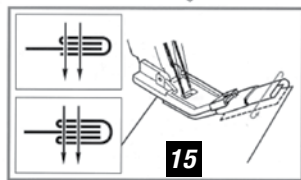
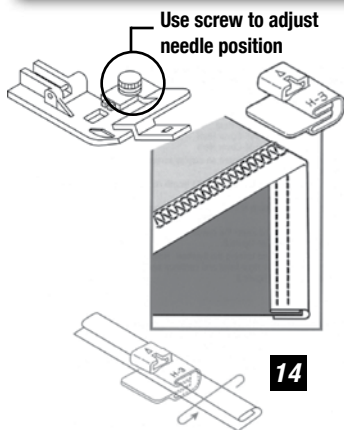

NOTE:

When sewing a curve, sew two or three stitches and adjust fabric in guide. Continue in same manner around entire curve. Avoid very tight curves.

OPTION:

Purchase extra wide double fold tape. Press out the center fold line for best results.

*Pressing only one side under (with the raw edge enclosed within the cover hem stitching) will be less bulky.

Cover Hem Foot (M): 200-801-304
Wrapped Edge Guide (H-3): 200-801-201

PINTUCKING FOOT (K) AND PINTUCKING GUIDE (K-1)

Creative serging occurs when the Cover Hem and pintucking foot are combined. The pintucking guide lifts lightweight to medium weight fabric to form a raised pintuck without the need for cording. Rows of pintucks are commonly seen in heirloom sewing.

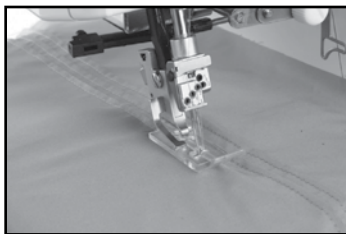

COVER HEM PINTUCKS

1. Select sewing program:
(10) Cover Hem Narrow
2. Thread and set up machine as indicated on the machine or in your instruction manual.
3. Attach pintucking foot.
4. Open left side cover. Slide slender end of K-1 guide under groove on pintucking foot. Insert peg on guide into needle plate hole, close left side cover. **See Figure 17.**
5. Position fabric (right side up) on top of K-1 guide and under foot. Lower needles into fabric and lower presser foot. **See Figure 18.**
6. Sew first two stitches by hand turning the hand-wheel. Continue sewing at a medium speed. Use presser foot edge as a guide for next row of pintucks.

Pintucking Foot:	200-802-202
Pintucking Guide (K-1):	200-802-006

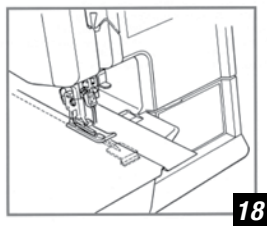
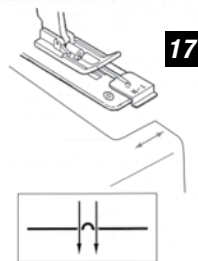
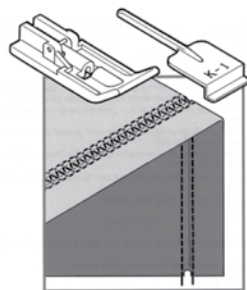



◀ PINTUCKING FOOT (K) AND CORDING GUIDE (K-2)

Create corded pintucks with ease. A trapunto effect is achieved when the Cover Hem, pintucking foot and cording guide are used together. The corded pintuck works well on medium weight and knit fabrics.

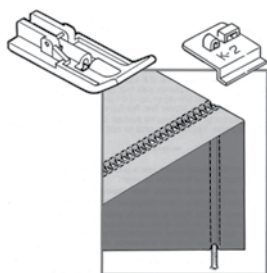

19

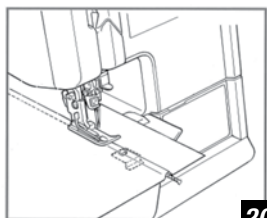
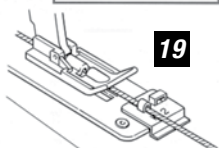

20

COVER HEM CORDED PINTUCKS

1. Select sewing program:
(10) Cover Hem Narrow
2. Thread and set up machine as indicated on the machine or in your instruction manual.
3. Attach pintucking foot.
4. Insert cord or yarn through tubular guide on K-2 guide. Open left side cover. Insert peg on K-2 guide into needle plate hole, close left side cover. Position cord under pintucking foot groove. Leave a 5 cm (2") tail behind foot. **See Figure 19.**
5. Lay fabric (right side up) on top of cord and under presser foot. Lower needles into fabric. Lower the presser foot. Sew first two stitches by hand turning the handwheel. Continue sewing at a medium speed. **See Figure 20.**

HINT:

Wrap the cord or yarn end with clear tape for easy insertion into the K-2 guide.

Pintucking Foot:	200-802-202
Cording Guide (K-2):	200-802-109

CORDING FOOT (Q) AND CORDING GUIDE (K-2)

Create your own decorative trims by couching over narrow ribbon using the Overlock 3 stitch and decorative thread (medium to heavy weight thread suitable for overlock machines) in the upper looper. Looks great in a single strand or braid several together to make unique decorative soutache. A perfect design accent for your next project.



CREATE DECORATIVE TRIM

1. Select sewing program:
(2) Overlock 3
2. Thread and set up machine as indicated on the machine or in your instruction manual with decorative thread in upper looper. Set Stitch Width Dial to widest width. Disengage (lower) cutting blade.
3. Attach cording foot.
4. Insert cord or tape through rectangular guide on K-2 guide. Open left side cover. Insert peg on K-2 guide into needle plate hole, close left side cover. **See Figure 21.**
5. Position cord/tape under presser foot to right side of needle, leaving a 5 cm (2") tail behind foot. Sew first two stitches by hand turning handwheel. Check thread tension for balanced stitch and make adjustments if needed. Sew over cord/tape to make one strand of braid. (If you are unable to use the K-2 guide, you will need to position the tape/cord properly while it feeds through the machine.) **See Figure 22.**
6. Make 3 strands to braid together. Hand sew braid onto project. **See Figure 23.**

Cording Foot (Q):	200-802-305
Cording Guide (K-2):	200-802-109

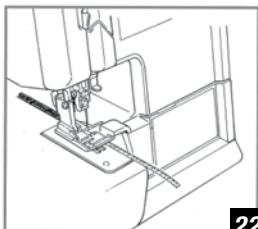
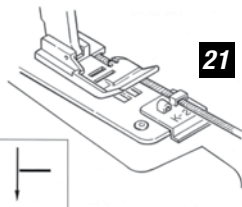
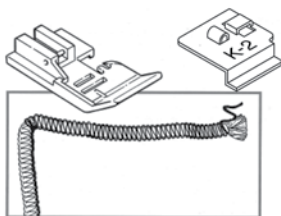

23

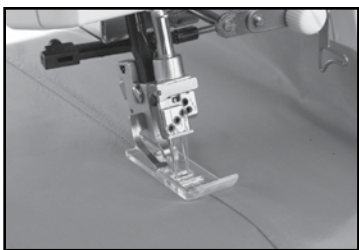

◀ TOPSTITCH FOOT (N) AND TOPSTITCH GUIDE (N-1)

The reinforced seam is an evenly topstitched seam that is much stronger than a simple overlock seam. It is recommended for activewear, pants, shirts and blouses. Also perfect for transparent fabrics, organdy and sheer crepe. This technique is ideal for securing easily frayed fabrics and tidying hems away. Use different colored threads for decorative effect.

REINFORCING SEAMS WITH THE COVER HEM

1. The seam is sewn first (right sides together) with a 3-Thread Stitch Wide, Overlock 3 or Chain stitch. Press seam to the right. **See Figure 24.**
2. Select sewing program:
(10) Cover Hem Wide
3. Thread and set up machine as indicated on the machine or in your instruction manual.
4. Attach topstitch foot.
5. Open left side cover. Insert peg on N-1 guide into needle plate hole; close left side cover. **See Figure 25.**
6. Place fabric right side up under presser foot with seam bulk in guide groove. Lower needles into overlock seam. Lower the presser foot. **See Figure 26.**
7. Sew first two stitches by hand turning the hand-wheel. Sew slowly and accurately in order to keep the seam in the groove. **See Figure 27.**

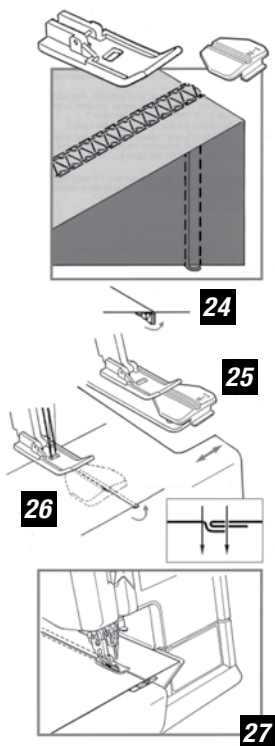

Topstitch Foot (N):	200-804-101
Topstitch Guide (N-1):	200-804-008

BLIND STITCH FOOT (D)

The adjustable guide on the blind stitch foot ensures that any weight of fabric is trimmed, overlocked and invisibly hemmed in one quick step. Change the stitch and it becomes a wonderful guide for decorative pin-tucks, lacy fagoting or flatlocking as seen in ready to wear.

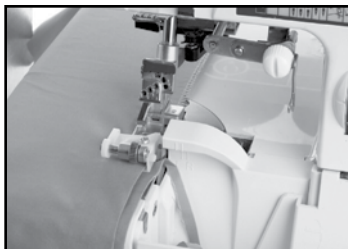

INVISIBLE HEMMING

What a great way to professionally hem a garment! The fabric edge is trimmed, overlocked and invisibly hemmed into place in one easy step.

1. Select sewing program:
(2) Overlock 3
2. Thread and set up machine as indicated on the machine or in your instruction manual.
Set SL between 4 – 5.
3. Attach blind stitch foot.
4. Fold and press hem under desired amount. Fold it again back toward right side. Leave a 7 mm (1/4") to 1 cm (3/8") extension of hem allowance to the right. Place hem under presser foot with folded edge against guide "A".

See Figure 28.

5. Lower presser foot. Slowly lower needle into folded edge. Adjust guide "A" by turning screw "B" so the needle just catches one or two fibers of the fold. See Figures 28 and 29.

6. Once the guide is adjusted correctly, continue sewing keeping folded edge against white plastic guide "A".

See Figure 30.

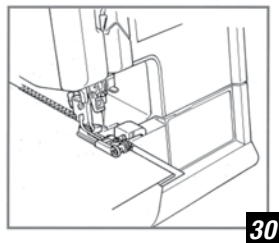
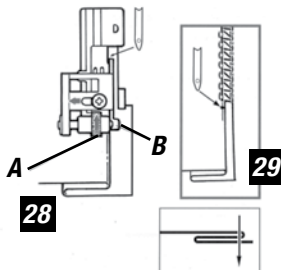
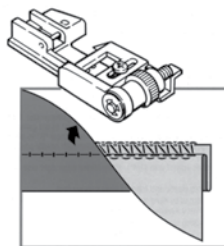

NOTE:

Loosen needle thread tension one number for bulky or crisp fabrics.

Blind Stitch Foot (D):

200-806-000

DECORATIVE FLATLOCK HEMMING

Hem your garments with a beautiful trellis or ladder effect. It's so easy with the blind stitch foot and flatlock stitch.

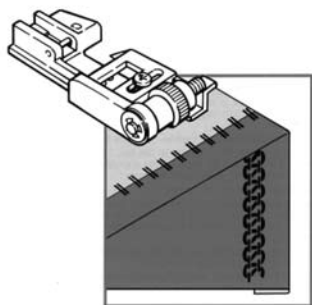

31

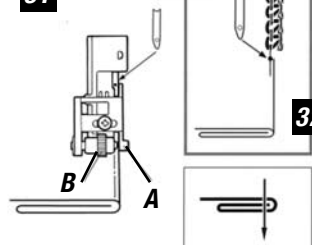

32

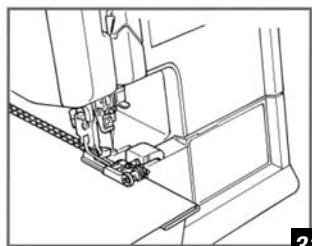

33

1. Select sewing program:
(3) Flatlock 3 or (5) Flatlock 2
2. Thread and set up machine as indicated on the machine or in your instruction manual.
3. Attach blind stitch foot.
4. Fold and press hem under desired amount; fold and press under hem a second time. Place hem under presser foot with second fold and raw edge inside second fold against guide "A". See Figure 31.
5. Lower presser foot. Slowly lower needle into folded edges. Adjust guide "A" by turning screw "B" so the stitch is formed half on fabric and half on "air or off fabric". See Figures 31 and 32.
6. Continue sewing; keep folded edges against guide "A". See Figure 33.
Pull hem flat. Notice the raw edge is encased under the ladder stitch on the underside.

VARIATION:

Fold and press hem under desired amount. Fold hem back on itself for a second fold; align second fold with raw hem edge, then sew. The ladder stitch will be on right side.

Blind Stitch Foot (D):

200-806-000

GATHERING FOOT (G)

With the gathering foot it's easy to create the evenly distributed gathers you want with light or medium weight fabrics. The gathering foot permits you to gather a ruffle, sew it to a flat fabric and overlock the edges in one operation.

GATHERING AND ATTACHING RUFFLE TO FLAT FABRIC

1. Select sewing program:
 - (1) Safety 4-Thread Stitch
2. Thread and set up machine as indicated on the machine or in your instruction manual.
 - Set SL between 3 – 4.
 - Set DF at 2.
 - Set Yellow tension to 6 and Blue tension to 5.
3. Attach gathering foot.
4. Place fabric "A" (fabric to be gathered) right side up under foot. Place fabric "B" (flat fabric) right side down into foot slot. **See Figure 34.**
5. To achieve a smooth, clean edge at the beginning, hand trim a notch from both fabric corners approximately 6 mm (1/4") deep and 4 cm (1-1/2") long. **See Figure 35.**
Lower needles into fabrics. Lower presser foot. Sew first two stitches by hand turning handwheel. Continue to sew using your right hand to hold upper fabric and your left hand to hold lower fabric. Be careful not to hold lower fabric too firmly, preventing it from gathering to its maximum. **See Figure 36.**

NOTE:

Set Pressure Adjustment Dial between 1 and 4 if more gathers are desired. Remember to reset dial back to 5 after gathering is complete.

Gathering Foot (G):

200-807-001

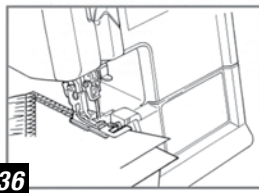
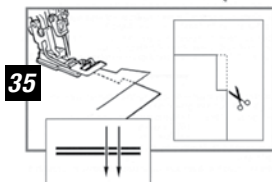
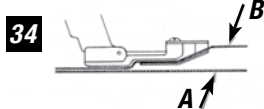
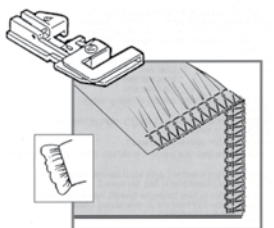



◀ BELT LOOP FOOT (L)

Easily duplicate the belt loops found in the garment industry using a Wide or Triple Cover Hem. This foot automatically folds under bias strip edges for belt loops, decorative accents, button loops, narrow straps, etc. The possibilities are limited only by your imagination.

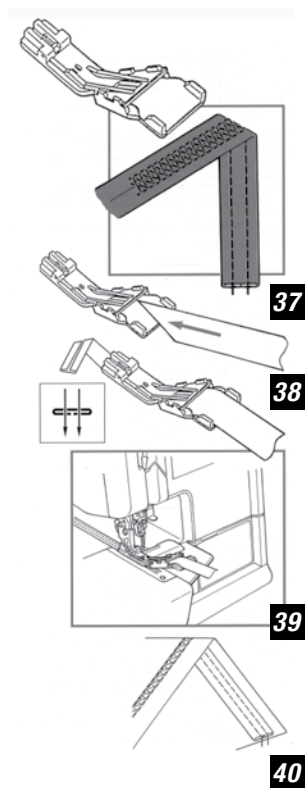

CREATING BELT LOOP DECORATIVE ACCENTS

1. Select sewing program:
(10) Triple Cover Hem or Cover Hem Wide
2. Thread and set up machine as indicated on the machine or in your instruction manual.
3. Cut a strip of bias tape 2.7 cm (1 1/8") wide. Cut one end at a 45° angle. Insert cut angle (fabric right side facing up) into belt loop foot.
See Figure 37.
4. Pull bias tape under foot and extend it behind foot. **See Figure 38.**
5. Attach belt loop foot.
6. Lower needles into bias tape. Lower presser foot. Be sure both edges of bias are turned under before stitching. Sew first two stitches by hand turning the handwheel. Sew belt loop strip at a medium speed. **See Figure 39.***

VARIATION 1:

Sew belt loops directly onto fabric for a decorative effect. Place a medium to heavy weight fabric underneath foot. Use a stabilizer on fabric to prevent puckering. **See Figure 40.**

VARIATION 2:

Sew belt loop strip. Use a sewing machine with clear monofilament needle thread to attach belt loop strip to fabric surface for decorative effect.

*NOTE:

For best results, pull fabric slightly to the left while sewing.

Belt Loop Foot (L):

200-808-002

BEADING FOOT (P)

Beaded trims add that special touch to any project from evening to casual wear. A deep groove on the underside of the beading foot guides strands of beads/pearls perfectly into place as they are secured with a flatlock stitch.



FLATLOCK BEADS/PEARLS ONTO FABRIC

1. Select sewing program:
(5) Flatlock 2
2. Thread and set up machine as indicated on the machine or in your instruction manual.
Set SL between 2.5 – 4 (should be same as diameter of beads/pearls).
3. Attach beading foot.
4. Draw a line with washable fabric marker for beads/pearls application. Fold fabric with wrong sides together on line. Place fold under presser foot about 3 mm (1/8") from needle plate edge. Lower needle into fabric. **See Figure 41.**
5. Place beads under foot groove and lower presser foot. **See Figure 42.**
6. Sew first two stitches by hand turning handwheel. Continue sewing; avoid puckering by holding beads behind foot. Remember, the needle should catch only 3 mm (1/8") of the fold so fabric will lay flat. **See figure 43.**
7. Pull fabric flat.

VARIATION:

Add beads to a hemline: Use a Narrow Hem 3 to finish edge before attaching beads. Proceed in same method as above, eliminating drawing line for placement.

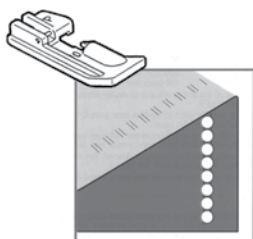

41

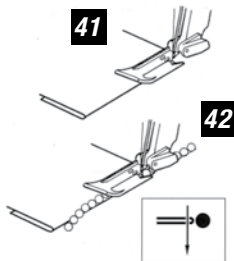

42

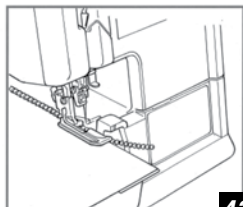

43

Beading Foot (P):

200-809-003

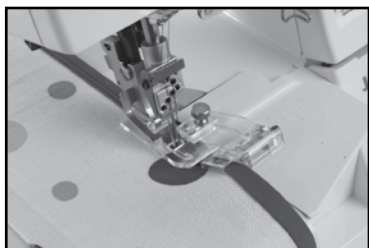

◀ ADJUSTABLE BIAS BINDER FOOT (M)

This adjustable foot allows you to attach 10 mm to 40 mm wide pre-folded bias tape. The foot facilitates the attachment of binding onto a lightweight or medium weight fabric edge using the Chainstitch. Creating the look you want has never been easier.

ATTACHING PRE-FOLDED BIAS TAPE TO AN EDGE

1. Select sewing program:
(10) Chainstitch
2. Thread and set up machine as indicated on the machine or in your instruction manual.
3. Use any size of pre-folded bias tape. Cut one end at a 45° angle. Insert cut angle into guide "A".
See Figure 44.
4. Pull bias tape under foot and extend it behind foot. Adjust the guide opening with screw "B" until bias tape folded edges are slightly touching left side of guide.
5. Attach bias binder foot (M).
6. Adjust position of bias guide with screw "C".
See Figure 45.
7. Lower needle into bias tape. Check screw "C" adjustment. Insert fabric edge into fold of bias tape. Lower the presser foot. **See Figure 46.**
8. Sew first two stitches by hand turning the hand-wheel. Sew at a slow speed holding fabric in left hand and bias tape in right hand.

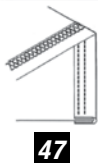
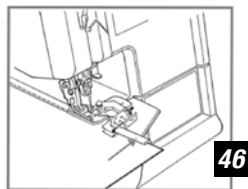
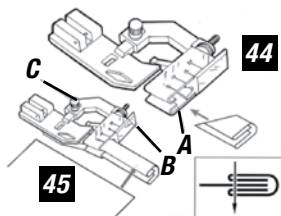
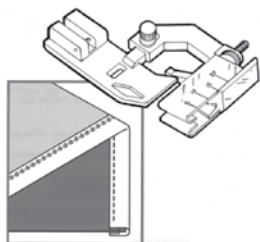

HINT:

When sewing a curve, lower needle, raise foot and reposition fabric against guide every two or three stitches. Lower foot and continue in same manner around entire curve. Avoid very tight curves.

NOTE:

Attach bias tape with a Cover Hem stitch using the same method. **See Figure 47.**

Adjustable Bias Binder Foot (M): 200-810-007

PIPING FOOT (E)

Create a tailored finish and add definition to edges with the piping foot. This foot allows you to add pre-made piping to edges and seams or to create custom piping using fabric and cording. Please note - cording must be size 30 to properly fill the groove in the piping foot.

CREATE PIPING

1. Select sewing program:
(10) Chainstitch
2. Thread and set up machine as indicated on the machine or in your instruction manual.
3. Attach piping foot.
4. Cut a strip of bias tape at least 3.5 cm (1 3/8") wide. Wrap bias tape around cord (size 30 diameter) with raw edge facing to the right.
5. Place the bias tape/cord under the piping foot with the cord to the left side of the needle. Lower the presser foot. Check that the cord is to the left side of the needle and in the foot groove.
6. Turn the handwheel to lower the needle into the fabric. Sew a short distance to ensure the bias tape is feeding smoothly.

Piping Foot (E): 200-814-104

CREATE AND INSERT PIPING INTO SEAM

Follow steps 1-6 above.

7. Place one piece of fabric, right side up, under the bias tape and second piece of fabric, right side down, on top of the bias tape.
8. Sew slowly, checking that the cord, bias tape and fabrics are being guided correctly. Check intermittently while sewing to ensure that the bias tape is wrapped tightly around the cord.

Piping Foot (E): 200-814-104



◀ CURVE GUIDE

This guide helps you to serge a curved edge and a straight edge together. It is a technique seen in commercially made home decor items such as knife edge pillows and bedsreads.

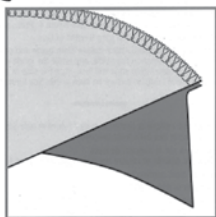
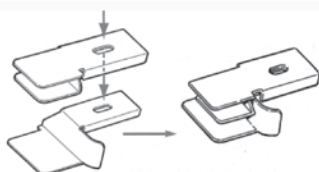

48

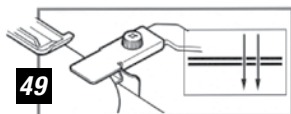
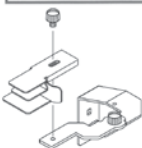

49

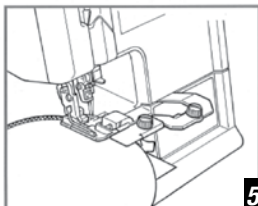

50

SEWING TOGETHER CURVED AND STRAIGHT EDGES

1. Select sewing program:
(1) Safety 4-Thread Stitch
2. Thread and set up machine as indicated on the machine or in your instruction manual.
3. Attach A/B foot.
4. Secure attachment holder base and attachment holder onto machine.*
5. Assemble curve guide top and bottom sections if needed. Secure curve guide onto attachment holder. **See Figure 48.**
6. Position flat fabric, right side up, against bottom portion of guide. Position curved fabric, right side down, against top portion of guide. Extend both fabrics under presser foot. Lower needles into fabrics. Lower the presser foot. **See Figure 49.**
7. Sew first two stitches by hand turning handwheel. Continue sewing with both fabric edges against the guide, holding the top fabric with your left hand and the bottom fabric with your right hand. It is very important that curved edge remains in contact with the guide while being sewn. **See Figure 50.**

Curve Guide (Top and Bottom Sections): 200-812-009
Attachment Holder Set: 200-812-102

*NOTE:

Attachment will be placed below of inside front cover.

TAPE BINDER

No need to pre-iron your bias strip; the tape binder automatically folds a 40 mm (1 1/2") bias strip at the same time it is applied to the fabric edge. It is the perfect finish for blankets, placemats and jackets. The binding is secured with the Chainstitch.

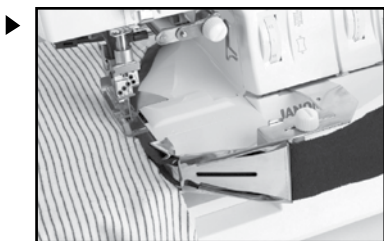

CREATING AND ATTACHING BIAS TAPE BINDING

1. Select sewing program:

(10) Chainstitch

2. Thread and set up machine as indicated on the machine or in your instruction manual.

3. Attach A/B foot. Secure attachment holder base and attachment holder onto machine. **See Figure 51.***

4. Cut a strip of bias tape 4 cm (1-1/2") wide. Cut one end at a 45° angle. Insert cut angle into tape binder. Right side of fabric should face machine as it enters binder. Check that fabric is inserted correctly. Secure tape binder onto attachment holder. **See Figure 52.**

5. Place bias tape under presser foot. Lower needle into folded bias tape. If necessary, reposition tape binder to have only 2 mm (1/8") of folded bias on left side of needle. **See Figure 53.**

6. Insert fabric edge into slot between the folded bias tape. Lower the presser foot. Sew first two stitches by hand turning handwheel. Continue sewing at a medium speed. Check if fabric and tape are feeding correctly. Readjust binder position when necessary. **See Figure 54.**

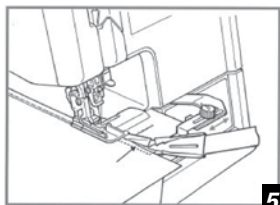
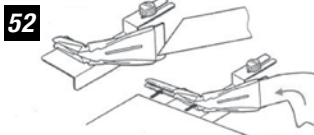
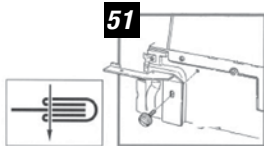
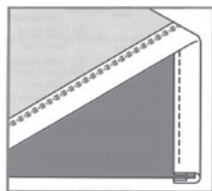
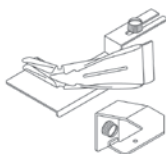

Tape Binder:	200-813-000
Attachment Holder:	200-813-103

*NOTE:

Front cover cannot open or close when attachment is in place.



◀ AUXILLIARY THREAD GUIDE

Prefer using industrial cone thread? Place extra large thread cones behind the machine on the table and attach the guide to the thread guide pole for smooth feeding of thread.

Auxilliary Thread Guide:

200-811-008

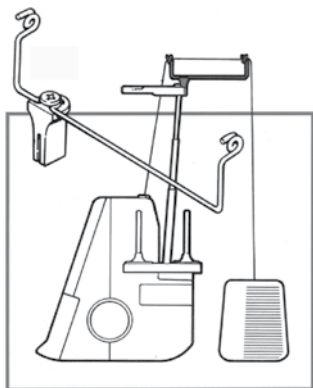

Notes

The 1200D doesn't just give you three machines in one – it provides an array of specialty tools to take advantage of this machine's amazing capabilities! With 28 optional feet and attachments, all of your sewing projects will get done quickly and easily. This instructional video provides detailed instructions for using many of the optional feet and attachments for the 1200D – so you can get started creating professional looking projects in no time.

Create the look you want the way you want it with Janome's combined overlock and cover stitch machine accessory range.



JANOME

Janome America, Inc.
10 Industrial Ave.
Mahwah, NJ 07430